

AIRDoctor®

BY IDEAL LIVING

Air. Always There, Protecting You and Your Air. Always.



USER MANUAL
AD2000i / AIR PURIFIER

THANK YOU

Congratulations on purchasing the AirDoctor 2000i Professional Air Purifier and your commitment to controlling the quality of your indoor air.

With the AirDoctor 2000i, we provide UltraHEPA® filtration to purify your indoor air. In addition, your AirDoctor is equipped with an Activated Carbon Filter to remove odor and VOCs (Volatile Organic Compounds). Get ready to experience cleaner air.

PLEASE NOTE: It is crucial that you read and follow all the instructions and safety warnings in this manual for optimal performance of your air purifier and your health and safety.

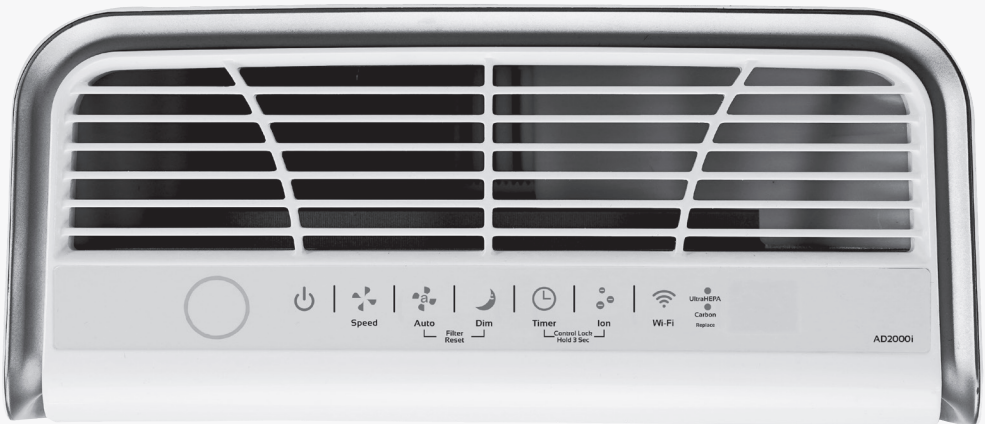

TABLE OF CONTENTS

SAFETY INSTRUCTIONS	2
PRODUCT BENEFITS	3
KNOWING YOUR AIRDOCTOR 2000i AIR PURIFIER	4
Main Parts	4
PROPER USAGE	5
OPERATING YOUR AIRDOCTOR AIR PURIFIER	6
Control Panel	6
Air Quality Monitor	6
Control Lock Feature	7
MAINTENANCE	8
Maintaining the AirDoctor Air Purifier	8
FAQ & TROUBLESHOOTING	9
CUSTOMER SERVICE CONTACT INFORMATION	11
AIRDOCTOR ONE-YEAR LIMITED WARRANTY	11
ARBITRATION AGREEMENT	12

SPECIFICATIONS

Dimensions:

13.85 inches wide
6.6 inches deep
18.72 inches tall

Weight:

10 lbs

Power Cord Length:

6 feet

Power Consumption:

8 watts on the
low setting and
55 watts on the
high setting.

SAFETY INSTRUCTIONS

WARNING: RISK OF ELECTRIC SHOCK

Safety precautions should always be used when operating this or any electrical appliance. Decrease the risk of electrocution, electric shock, injury or fire by reading and following all the warnings below.

Use this product only as described in this AirDoctor professional air purifier owners manual. To reduce the risk of electric shock, do not attempt to service the product in any way other than in the manner described in the "Maintenance" section of this guide.

- ⦿ Read all instructions before operating the AirDoctor Professional Air Purifier.
- ⦿ This product operates at 120V AC, 60Hz only.
- ⦿ Do not run the power cord under carpets or cover with throw rugs.
- ⦿ Do not operate the product in a greasy environment such as in the kitchen. This product is not intended to filter oil or grease from the air.
- ⦿ Do not use the AirDoctor Professional Air Purifier in bathrooms, near sinks or other wet and humid environments, near fireplaces or in areas where flammable or combustible vapors or products may exist.
- ⦿ Always unplug the power cord from the electrical outlet when the purifier is not in use, before cleaning, inserting or removing parts or before moving to another location.
- ⦿ Never run the air purifier unless it is fully assembled.
- ⦿ To reduce the risk of electric shock, this product has a polarized plug (one blade is wider than the other). This plug will fit into a polarized outlet only one way. If the plug does not fit into the outlet, contact qualified service personnel to install the proper outlet. Do not alter the plug in any way.
- ⦿ Always turn off all controls before unplugging the AirDoctor Professional Air Purifier from outlet.
- ⦿ Attempting to service the AirDoctor Professional Air Purifier in any way not described in this owner's guide will void the warranty and could cause serious personal injury to the user and/or result in considerable damage to the unit.
- ⦿ Do not place the cord near a heated surface.
- ⦿ Never operate the AirDoctor Professional Air Purifier if the plug or cord is damaged or appears damaged. Only qualified service personnel should replace a damaged power cord.
- ⦿ Never use the power cord to pick up, carry, drag, pull or lift the AirDoctor Professional Air Purifier. Do not pull the cord against or around sharp corners and edges. This could result in injury to the user or damage to the cord.
- ⦿ Always remove the plug from its power outlet by holding onto the plug itself and pulling gently. Never pull on the cord itself to unplug it from its power outlet.
- ⦿ Use care when operating the AirDoctor Professional Air Purifier by keeping all foreign objects, fingers and other body parts, hair, loose clothing and jewelry away from openings.
- ⦿ Never touch the AirDoctor Professional Air Purifier or its plug when your hands are wet.
- ⦿ The AirDoctor Professional Air Purifier is an electrical appliance. Adult supervision is required when operating around children.

FCC STATEMENT

This equipment has been tested and found to comply with the limits for a Class B digital device, pursuant to part 15 of the FCC Rules. These limits are designed to provide reasonable protection against harmful interference in a residential installation. This equipment generates, uses and can radiate radio frequency energy and, if not installed and used in accordance with the instructions, may cause harmful interference to radio communications. However, there is no guarantee that interference will not occur in a particular installation. If this equipment does cause harmful interference to radio or television reception, which can be determined by turning the equipment off and on, the user is encouraged to try to correct the interference by one or more of the following measures:

- Reorient or relocate the receiving antenna.
- Increase the separation between the equipment and receiver.
- Connect the equipment into an outlet on a circuit different from that to which the receiver is connected.
- Consult the dealer or an experienced radio/TV technician for help.

Changes or modifications not expressly approved by the party responsible for compliance could void the user's authority to operate the equipment.

This device complies with part 15 of the FCC Rules. Operation is subject to the following two conditions:

1. This device may not cause harmful interference.
2. This device must accept any interference received, including interference that may cause undesired operation.

PRODUCT BENEFITS

The AirDoctor professional air purifier boasts many great features:

- ⊙ UltraHEPA Filter removes microscopic particles from the air.
- ⊙ High-quality Carbon Filter removes VOCs (Volatile Organic Compounds) and controls odors.
- ⊙ Powerful and quiet fan has four speed settings so you can select the desired cleaning level.
- ⊙ Air Quality Monitor shows current air quality.
- ⊙ Auto mode automatically adjusts fan speed depending on air quality.
- ⊙ A 24-hour timer to set the time of operation, from 1 hour up to 24 hours.
- ⊙ Built-in ionizer revitalizes air.
- ⊙ Night mode dims the control panel lights when you sleep.
- ⊙ Clean filter indicator lights.
- ⊙ Low-power, consumption-energy efficient.
- ⊙ Control lock feature to avoid accidental changing of setting.
- ⊙ Mobile/Wi-Fi Connectivity.

Replacement Filters

- UltraHEPA® Filter
 - Carbon Filter
 - Pre-Filter
-

To order replacement filters go to
airdoctorpro.com or call **800.221.2515**.

KNOWING YOUR AIRDOCTOR 2000i AIR PURIFIER

MAIN PARTS

1. Front Cover
2. Pre-Filter (Black foam attached to Carbon Filter)
3. Carbon/Gas Trap/VOC Filter
4. UltraHEPA® Filter
5. Air Outlet
6. Touch Control Panel
7. Air Quality Sensor Cover
8. Air Quality Particle Sensor
9. Air Quality Monitor: The display will change color depending on air quality.

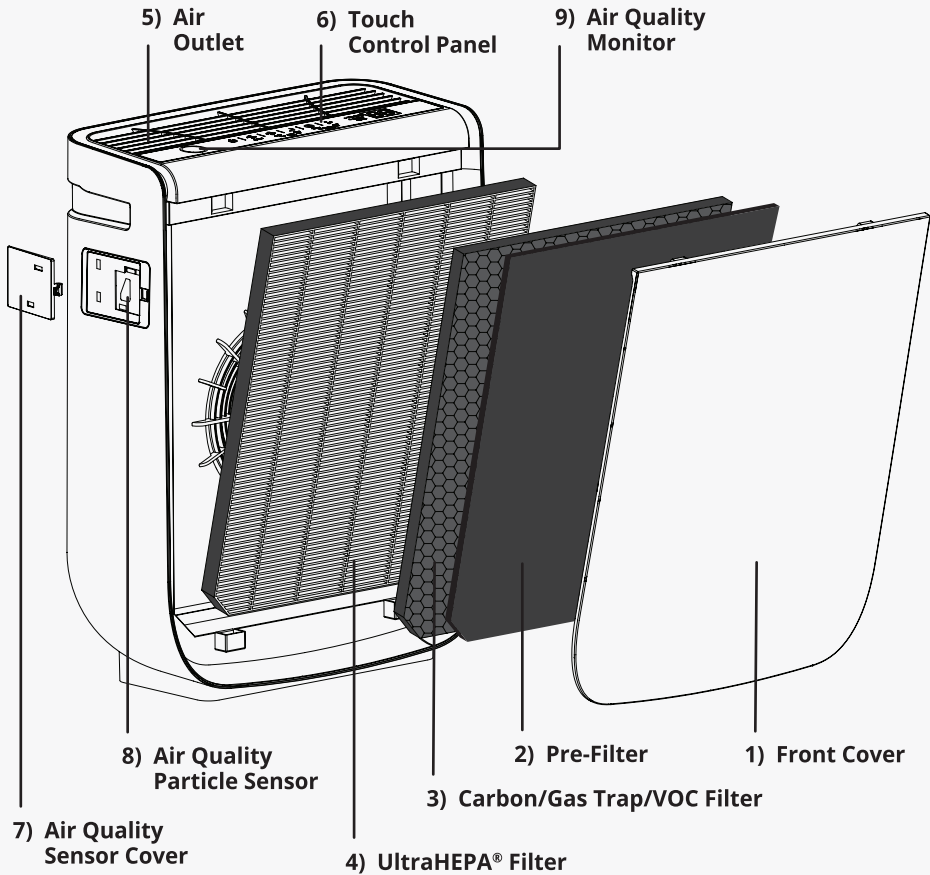

PROPER USAGE

Please note: Make sure the UltraHEPA and Carbon/Gas Trap/VOC Filters are properly installed before use.

1. Keep both sides of the unit more than 1 foot away from a wall.
2. Do not blow air from a fan or air conditioner directly into the air purifier.
3. Do not place the unit where the air inlet or outlet grill could come in contact with curtains or drapery.
4. Place the unit close to the source of air pollution to improve indoor air quality effectively.
5. Always place/keep the unit on the floor/ground.

1

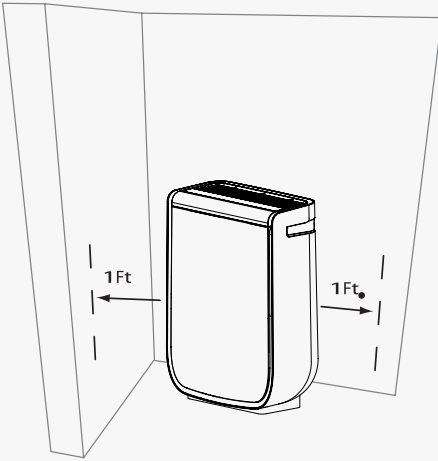

2



3



4-5

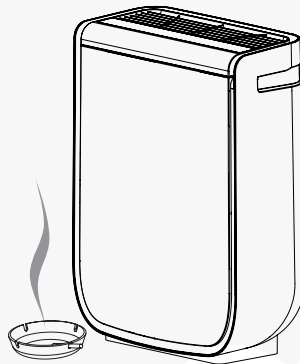

OPERATING THE AIRDOCTOR 2000i AIR PURIFIER

Before first use, remove filters and remove plastic bags from the Carbon Filter, then reinstall filters and front cover.

Plug the unit into an electrical outlet, and it will be ready to run. Read the following instructions to select desired settings.

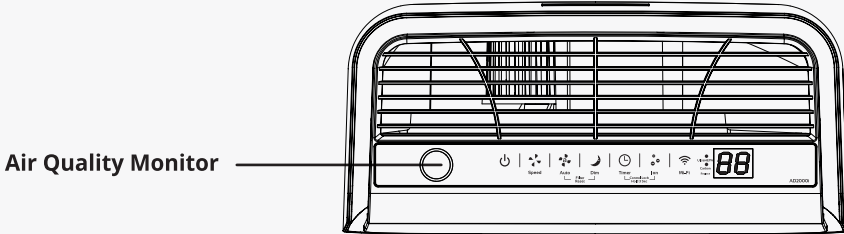

AIR QUALITY MONITOR

The AirDoctor comes with an Air Quality Monitor that continuously monitors the quality of air in a room. The LED indicator light, located on the top of the unit, will change colors based on the air quality in the room. The Air Quality Monitor is able to show three air quality levels.

BLUE = Good air quality / **ORANGE** = Moderate air quality / **RED** = Poor air quality

You can choose to set the AirDoctor to **Auto**. This will enable the AirDoctor to adjust the fan speed according to the air quality. In Auto mode, the fan speed will be adjusted as follows:

Good Air Quality = Low fan speed

Moderate Air Quality = Medium fan speed

Poor Air Quality = High and Boost fan speeds

CONTROL PANEL

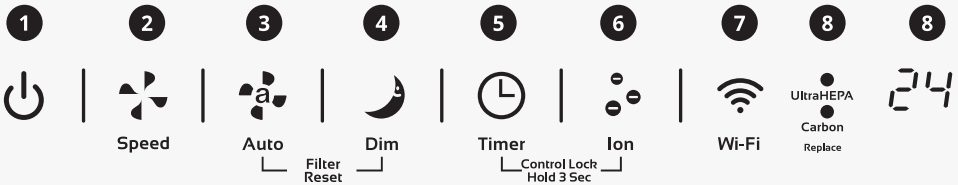

1. Power Control

As soon as you press the power button , the AirDoctor will start in the Auto mode. Once the Auto mode has been activated, it will start up in the high-speed mode, and the sensor will start to detect the amount of particulate matter in the air. As the particles are detected, the AirDoctor will automatically adjust to the purification speed (fan speed) that is appropriate to the particulate contamination in the room.

In most cases, we recommend that you leave the AirDoctor in the Auto mode. For other purification modes, see the next page.

OPERATING THE AIRDOCTOR 2000i AIR PURIFIER

2. Fan Speed Control

The AirDoctor has four different fan speed settings: Low, Medium, High and Boost. Each mode has its own indicator light that lights up when the setting is chosen. The speed selected determines how rapidly you want to clean the air. The “**Low**” and “**Medium**” settings are great for everyday use. The “**High**” setting is great for areas with more airborne contaminants (such as excessive smoke, pet dander, etc.) or areas used frequently by allergy sufferers. The “**BOOST**” setting is best used for shorter bursts of time when you want to rapidly purify the air.

3. Auto Mode

The AirDoctor is equipped with an air quality sensor to monitor the quality of your air. Simply press the **Auto** button to activate the air-monitoring system. The monitor will test the air quality and automatically adjust the fan speed to remove the air contaminants. The **LED ring** is on the top of the unit to notify you of the air quality; **RED** color for poor, **ORANGE** for moderate and **BLUE** for good quality air.

4. Dim Mode

If the LED lights are too bright, activate the “**Dim Mode**” to turn them off.

5. Timer Control

The AirDoctor Professional Air Purifier can be programmed to turn off after a preset amount of time. Press the “**TIMER**” button to program the timer. Each press will add 1 hour up to a total of 24 hours. Keeping the button pressed will automatically increase to 24 hours, 1 hour at a time. To turn off the timer, cycle through the numbers until you reach the beginning, and no numbers show on the display.

6. Ionizer

The ionizer will generate negative ions. This helps boost filtration performance by causing contaminants to clump together and making them easier to capture, but also creates a fresh air feeling. Press the **Ion** button to turn on the ionizer. Press it again to turn it off.

7. Wi-Fi

Use this button to put your unit into **Discovery Mode**. Press and hold the Wi-Fi button for 3 seconds until the Wi-Fi symbol starts to flash.

8. Replace Filter Indicator Light

The AirDoctor Replace Filter Indicator Light will turn on each time a filter needs to be replaced. To reset the Replace Filter alert after you have changed out the appropriate filter, **press the Auto and Dim together for 3 seconds**. The **REPLACE FILTER** light will flash three times and then turn off completely, indicating the unit has been reset.

9. 24-Hour Timer Display

CONTROL LOCK FEATURE

The AirDoctor has a control lock feature to prevent a person (child) or a pet from interrupting the running mode by accident. When the control lock feature has been activated, none of the buttons on the control panel will work. The only way to change any setting is to deactivate the control lock feature or to unplug the AirDoctor.

To activate control lock feature

- Press “**Timer**” and “**Ion**” at the same time for **3 seconds**
- This may be done at any time while the AirDoctor is running, including on Dim mode

To deactivate control lock feature

- Press “**Timer**” and “**Ion**” at the same time for **3 seconds**

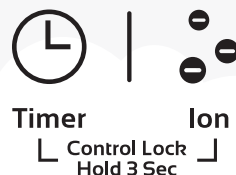

MAINTENANCE

The AirDoctor professional air purifier is almost maintenance-free! The high-quality Carbon/Gas Trap/VOC Filter lasts up to six months and our UltraHEPA Filter lasts up to 12 months, depending on use and environment conditions. Before replacing the UltraHEPA or Carbon/Gas Trap/VOC Filter of your AirDoctor professional air purifier, turn off and unplug the unit from the electrical outlet and read all safety instructions and important warnings in this owner's manual.

REPLACING THE ULTRAHEPA AND CARBON/GAS TRAP/VOC FILTERS:

1. Make sure the unit is turned off and unplugged. With the front of the unit facing forward, pull the lid toward you at the upper end as shown and remove the front cover.
2. Remove the UltraHEPA and Carbon/Gas Trap/VOC Filters by lifting and pulling the tabs on both sides of the filters.
3. Insert the new filter(s) that need replacing, then insert the bottom of the inlet grill first and then snap the upper part of the front cover back into position.
4. To close the front cover, first make sure the bottom hooks are properly in place before snapping it up to its upright and locked position.
5. After replacing the filters, hold down the auto and dim buttons on the control panel to reset the replace filter lights.

The importance of Genuine AirDoctor Replacement Filters!

Genuine AirDoctor replacement filters are guaranteed by AirDoctor and independently tested to remove dangerous airborne contaminants. Generic (third-party) aftermarket filters are of dubious quality, are not tested for effectiveness and are not certified to work with AirDoctor to maintain the Energy Star and CARB certification. AirDoctor has tested several generic filters that do not even meet the minimum HEPA standard. For air quality you can trust, and to maintain the optimal performance you depend on from AirDoctor, always use genuine AirDoctor replacement filters.

Warning: The use of generic, third-party replacement filters can damage your AirDoctor purifier and void your warranty.

CLEANING THE PRE-FILTER

1. Make sure the unit is turned off and unplugged. With the unit facing forward, pull the cover towards you at the upper end and remove the front cover.
2. Gently vacuum your Pre-Filter. You may do this monthly or as needed if there is more build-up.
3. After you've vacuumed your Pre-Filter, simply place the front cover back on your AirDoctor.

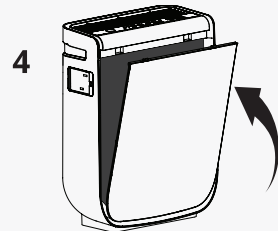
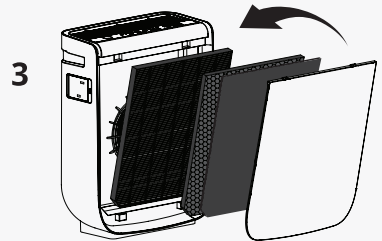
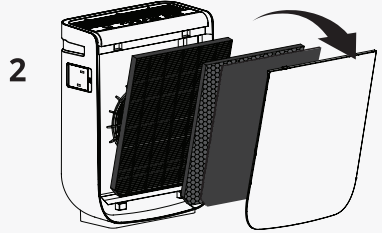
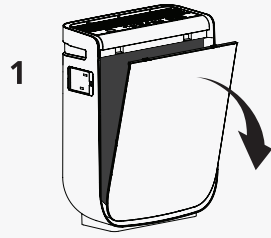

MAINTENANCE

SENSOR CLEANING MAINTENANCE

The AirDoctor is designed with an air quality sensor to track the quality of your air. Over time, the sensor can become dirty and may require cleaning. The main symptom of a dirty air quality sensor is when the LED air quality monitor display remains frozen on one color light. In order to clean it, follow the instructions below.

1. Power off and unplug unit.
2. Locate and open the air quality sensor cover located on the side of the unit. (Fig. 1)
3. Locate the lens of the air sensor located inside the air sensor. (Fig. 2)
4. Use one end of a cotton swab to wipe the lens and remove any debris. Repeat as needed. (Fig. 3)

Caution: Do not scratch the lens with a hard object.

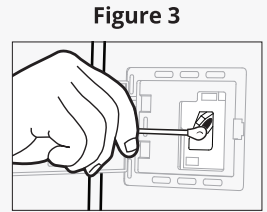
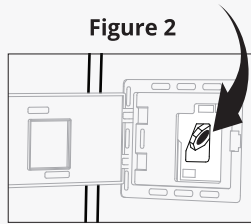
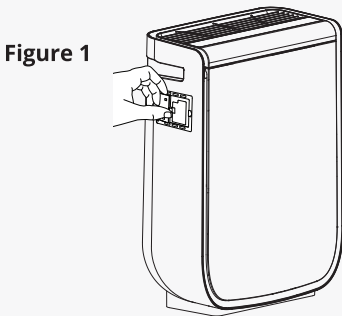

FAQ & TROUBLESHOOTING

Before contacting our customer service department, please try the following solutions:

QUESTION	ANSWER
How often should I change the filters?	UltraHEPA - 12 months Carbon/Gas Trap/VOC - 6 months
Can I wash my filters?	It is important that you never wash your UltraHEPA or Carbon/VOC Filters. Doing so will damage your filters, making them unusable. Your Pre-Filter was designed to be reusable. Avoid washing your Pre-Filter as you do not want to introduce any moisture onto the filters. We recommend vacuuming your Pre-Filter monthly for best maintenance and to extend the life of your filters until the next filter change.
How long is the power cord?	The power cord is 6 feet long.

FAQ & TROUBLESHOOTING

Before contacting our customer service department, please try the following solutions:

QUESTION	ANSWER
How much electricity does AirDoctor use?	AirDoctor is highly energy-efficient, only consuming 8 watts on the low setting and 55 watts on the high setting. While utility costs vary across the country, AirDoctor costs about \$30-40 per year to run on Auto-mode 24/7.
Why is the air sensor always red?	<p>If you feel that the sensor is always running on red (always at a high speed) never goes back to blue, please try the following tests:</p> <ol style="list-style-type: none">1. Turn your AirDoctor off, on the right side there should be a little panel door. This is the air sensor; open it.2. Clean the air sensor lens by following the instructions on page 9. Test to see if this improves and if there is a color change on the air quality monitor indicator light. <p>If this did not help, please do the following to test your air sensor:</p> <ol style="list-style-type: none">1. Move the AirDoctor into a small unused room like a closet or bathroom and make sure windows and doors are closed. Then turn the AirDoctor on the high-speed setting.2. After you've done this, leave the unit running on Auto mode for 60 min.3. Now check to see if the LED light has changed color4. If the air sensor LED light did not change color, please contact customer service.
Why is the air sensor always blue?	<p>The blue light indicates that AirDoctor is maintaining healthy air quality. We recommend that you keep the unit in Auto mode as it will automatically adjust to the purification needs of the room.</p> <p>If you feel that the sensor is no longer working, please try the following tests:</p> <ol style="list-style-type: none">1. Turn on the AirDoctor and let it run for two minutes.2. Locate the air sensor on the left side of the air purifier. It's behind a small door.3. Then, light up a match/candle and blow it out and make sure the smoke is directed towards the air sensor. You can also try to take an old pillow and fluff it next to the sensor.4. After you've blown up the smoke near it, the light on your AirDoctor should turn orange/red within a minute or so.5. If the air quality monitor LED light did not change color, please contact customer service.

AIRDOCTOR ONE-YEAR LIMITED WARRANTY

Your AirDoctor professional air purifier is warranted to be free from defects in materials and workmanship for one year from the original purchase date. Should the product have a defect in materials or workmanship, we will repair or replace it without charge to you (a shipping and processing fee will apply). To obtain service under warranty, simply call our customer service center toll-free at **800.221.2515**.

This warranty does not cover damage caused by accident, misuse or any use other than as intended and described in this product manual, or damage resulting from failure to maintain and clean this product as specified in this product manual. This warranty applies only to the original purchaser of the AirDoctor 2000i professional air purifier. This warranty does not cover the filters.

AIRDOCTOR VOC, HEPA AND PRE-FILTER LIMITED WARRANTY

Your AirDoctor particle filter (HEPA) and VOC (carbon) and Pre-Filter is warranted to be free from defects in material and workmanship for 30 days from the original purchase date. AirDoctor will replace a defective filter at no charge to you and cover any shipping charges. The limited warranty covers normal use only.

ALL EXPRESS AND IMPLIED WARRANTIES FOR THIS PRODUCT, INCLUDING IMPLIED WARRANTIES OF MERCHANTABILITY AND FITNESS FOR A PARTICULAR PURPOSE, ARE LIMITED IN DURATION TO THE WARRANTY PERIOD, AND NO WARRANTIES, WHETHER EXPRESS OR IMPLIED, WILL APPLY AFTER THIS PERIOD.

Some states do not allow limitations on the duration of implied warranties, so the above limitation may not apply to you. While this warranty gives you specific legal rights, you may also have other rights which may vary from state to state.

CONTACT INFO FOR WARRANTY SERVICE:

AirDoctor

P.O. Box 9159 | Van Nuys, CA | 91409-8291

800.221.2515 | airdoctorpro.com

©2023 AirDoctor, LLC. All Rights Reserved.

AIRDoctor[®]
BY IDEAL LIVING

ARBITRATION AGREEMENT

PLEASE READ THIS AGREEMENT CAREFULLY. YOU ACCEPT THE TERMS OF THIS AGREEMENT BY RETAINING THE PRODUCT(S) SHIPPED IN CONNECTION WITH THIS AGREEMENT (THE "PRODUCTS") FOR MORE THAN THIRTY (30) DAYS AFTER RECEIPT. IF YOU DO NOT AGREE TO THE TERMS OF THIS AGREEMENT, YOU MAY RETURN THE PRODUCT TO THE COMPANY WITHIN THIRTY (30) DAYS OF RECEIPT FOR A FULL REFUND.

THIS ARBITRATION AGREEMENT ("AGREEMENT") AFFECTS YOUR LEGAL RIGHTS AND REMEDIES BY PROVIDING THAT DISPUTES BETWEEN YOU AND THE MANUFACTURER, DISTRIBUTOR AND/OR SELLER OF THIS PRODUCT (COLLECTIVELY, "COMPANY"), MUST BE RESOLVED THROUGH BINDING ARBITRATION AND NOT IN COURT. IT ALSO PROVIDES THAT ANY DISPUTE CANNOT BE RESOLVED IN A CLASS ACTION OR OTHER PROCEEDING WHERE YOU REPRESENT OTHER PERSONS OR OTHER PERSONS REPRESENT YOU, AND THAT NO CLASS OR REPRESENTATIVE ARBITRATIONS ARE PERMITTED. PLEASE CAREFULLY READ ALL TERMS IN THIS AGREEMENT.

- 1. RESOLUTION OF CLAIMS OR DISPUTES.** Any claim or dispute between you and the Company (or any of the Company's subsidiaries or affiliates) arising out of or relating in any way to the Product or this Agreement shall be resolved through final, binding arbitration. This arbitration obligation is reciprocally binding on both you and the Company and applies regardless of whether the claim or dispute involves a tort, fraud, misrepresentation, product liability, negligence, violation of a statute, or any other legal theory. Both you and the Company specifically acknowledge and agree that you waive your right to bring a lawsuit based on such claims or disputes and to have such lawsuit resolved by a judge or jury.
- 2. LIMITATION OF LEGAL REMEDIES.** All arbitrations under this Agreement shall be conducted on an individual (and not a class-wide) basis, and an arbitrator shall have no authority to award class-wide relief. You acknowledge and agree that this Agreement specifically prohibits you and the Company from commencing arbitration proceedings as a representative of others or joining in any arbitration proceedings brought by any other person. The parties agree that no class or representative actions of any type are permitted.
- 3. ARBITRATION PROCEDURES.**
 - a. Before instituting an arbitration, if you have any dispute, we strongly encourage you to contact the Company to try to resolve the matter by calling 800.221.2515, although you are not required to do so.
 - b. The arbitration of any claim or dispute under this Agreement shall be conducted in accordance with the expedited procedures set forth in the JAMS Comprehensive Arbitration Rules and Procedures as those Rules exist on the date you receive the Product, including Rules 16.1 and 16.2 of those Rules. These rules and procedures are available by calling JAMS or by visiting its website at jamsadr.com. The arbitration of any claim or dispute under this Agreement shall be conducted by an arbitrator who has at least five years of experience conducting arbitrations.
 - c. The arbitration of any claim or dispute under this Agreement shall be conducted in the State of California or the location in which you received this Agreement. For claims of \$10,000 or less, you may choose whether the arbitration proceeds in person, by telephone, or based only on submissions.
 - d. The Company shall pay costs for the arbitration of claims, including any JAMS Case Management Fee and all professional fees for the arbitrator's services. The Company shall pay the fees and costs of its own counsel, experts and witnesses and shall not be able to recoup them from you even if you do not prevail in the arbitration. Unless otherwise provided by law, you acknowledge and agree that you shall pay the fees and costs of your own counsel, experts and witnesses.
- 4. CHOICE OF LAW.** The arbitration provisions of this Agreement and any arbitration conducted pursuant to the terms of this Agreement shall be governed by the Federal Arbitration Act (9 U.S.C. Secs. 1-16). In this respect, the parties acknowledge that this Agreement involves a transaction conducted in interstate commerce. Otherwise, this Agreement and the rights of the parties hereunder shall be governed by and construed in accordance with the laws of the State of California, exclusive of conflict or choice of law rules.
- 5. SEVERABILITY.** If any provision of this Agreement is declared or found to be unlawful, unenforceable or void, such provision will be ineffective only to the extent that it is found unlawful, unenforceable or void, and the remainder of the provision and all other provisions shall remain fully enforceable.

ACUERDO DE ARBITRAJE

LEA ATENTAMENTE ESTE ACUERDO. USTED ACEPTA LOS TÉRMINOS DE ESTE ACUERDO AL CONSERVAR EL PRODUCTO (LOS PRODUCTOS) ENVIADOS BAJO A ESTE ACUERDO (LOS "PRODUCTOS") POR MÁS DE TREINTA (30) DÍAS DESPUÉS DE SU RECEPCIÓN. SI NO ESTÁ DE ACUERDO CON LOS TÉRMINOS DE ESTE ACUERDO, PUEDE DEVOLVER EL PRODUCTO A LA EMPRESA EN UN PLAZO DE TREINTA (30) DÍAS A PARTIR DE HABERLO RECIBIDO PARA OBTENER UN REEMBOLSO COMPLETO.

ESTE ACUERDO DE ARBITRAJE ("ACUERDO") AFECTA A SUS DERECHOS Y RECURSOS LEGALES AL ESTABLECER QUE LAS DISPUTAS ENTRE USTED Y EL FABRICANTE, DISTRIBUIDOR Y/O VENDEDOR DE ESTE PRODUCTO (COLECTIVAMENTE, "COMPAÑÍA"), DEBEN RESOLVERSE MEDIANTE ARBITRAJE VINCULANTE Y NO EN LOS TRIBUNALES. TAMBIÉN ESTABLECE QUE CUALQUIER DISPUTA NO PUEDE SER RESUELTA EN UNA ACCIÓN COLECTIVA U OTRO PROCEDIMIENTO EN EL QUE USTED REPRESENTA A OTRAS PERSONAS O QUE OTRAS PERSONAS LE REPRESENTAN A USTED, Y QUE NO SE PERMITEN ARBITRAJES COLECTIVOS O REPRESENTATIVOS. POR FAVOR LEA DETENIDAMENTE TODOS LOS TÉRMINOS DE ESTE ACUERDO.

1. RESOLUCIÓN DE RECLAMACIONES O DISPUTAS.

Cualquier reclamación o disputa entre usted y la Compañía (o cualquiera de las subsidiarias o filiales de la Compañía) que surja o esté relacionada de alguna manera con el Producto o este Acuerdo se resolverá mediante un arbitraje final y vinculante. Esta obligación de arbitraje es recíprocamente vinculante tanto para usted como para la Compañía y se aplica independientemente de si la reclamación o disputa implica un agravio, fraude, tergiversación, responsabilidad por el producto, negligencia, violación de una ley o cualquier otra teoría legal. Tanto usted como la Compañía reconocen y aceptan específicamente que renuncian a su derecho a presentar una demanda judicial basada en dichas reclamaciones o disputas y a que dicha demanda sea resuelta por un juez o un jurado.

2. LIMITACIÓN DE LOS RECURSOS LEGALES.

Todos los arbitrajes en virtud del presente Acuerdo se llevarán a cabo de forma individual (y no colectiva), y un árbitro no tendrá autoridad para conceder una reparación colectiva. Usted reconoce y acepta que este Acuerdo le prohíbe específicamente a usted y a la Compañía iniciar procedimientos de arbitraje como representante de otros o unirse a cualquier procedimiento de arbitraje presentado por cualquier otra persona. Las partes acuerdan que no se permiten acciones colectivas o representativas de ningún tipo.

3. PROCEDIMIENTOS DE ARBITRAJE.

- Antes de iniciar un arbitraje, si tiene alguna disputa le recomendamos encarecidamente que se ponga en contacto con la Compañía para intentar resolver el asunto llamando al 800.221.2515, aunque no está obligado a hacerlo.
- El arbitraje de cualquier reclamación o disputa en virtud de este Acuerdo se llevará a cabo de acuerdo con los procedimientos acelerados establecidos en las Normas y Procedimientos de Arbitraje Integrales de JAMS, tal y como existían en la fecha en que usted recibió el Producto, incluidas las Normas 16.1 y 16.2 de dichas Normas. Estas normas y procedimientos están disponibles llamando a JAMS o visitando su sitio web en www.jamsadr.com. El arbitraje de cualquier reclamación o disputa en virtud de este Acuerdo será llevado a cabo por un árbitro que tenga al menos cinco años de experiencia en la realización de arbitrajes.
- El arbitraje de cualquier reclamación o disputa en virtud de este Acuerdo se llevará a cabo en el Estado de California o en el lugar en el que usted recibió este Acuerdo. En el caso de reclamaciones de \$10,000 o menos, usted podrá elegir si el arbitraje se lleva a cabo en persona, por teléfono o únicamente basado en la presentación de documentación.
- La Compañía pagará los costes del arbitraje de las reclamaciones, incluyendo cualquier tasa de gestión de casos de JAMS y todos los honorarios profesionales por los servicios del árbitro. La Compañía pagará los honorarios y costes de sus propios abogados, peritos y testigos y no podrá recuperarlos de usted aunque no prevalezca en el arbitraje. A menos que la ley disponga lo contrario, usted reconoce y acepta que pagará los honorarios y costes de su propio abogado, peritos y testigos.

4. ELECCIÓN DE LA LEY.

Las disposiciones de arbitraje de este Acuerdo y cualquier arbitraje llevado a cabo de conformidad con los términos de este Acuerdo se regirán por la Ley Federal de Arbitraje (9 U.S.C. Artículos 1-16). A este respecto, las partes reconocen que este Acuerdo implica una transacción realizada en el comercio interestatal. Por lo demás, el presente Acuerdo y los derechos de las partes en virtud del mismo se regirán e interpretarán de acuerdo con las leyes del Estado de California, excluyendo las normas de conflicto o elección de la ley.

5. DISPOSICIONES INDEPENDIENTES.

Si alguna de las disposiciones del presente Acuerdo se declara o se considera ilegal, inaplicable o nula, dicha disposición será ineficaz sólo en la medida en que se considere ilegal, inaplicable o nula, y el resto de las disposiciones y todas las demás cláusulas seguirán siendo aplicables plenamente.

AIRDoctor®

BY IDEAL LIVING

Guard Your Air. Always There, Protecting You and Your

